

Design of a Rectenna for Energy Harvesting in the 2.45 GHz Band

^{1*} Mr. Bikash Kumar Swain, ² Mr. Ajit ku Mohapatra

^{1*} *Asst. Professor, Dept. Of Electrical Engineering, NIT BBSR,*

²*Asst. Professor DEPT. of Electrical Engineering, NIT BBSR,*

^{1*}bikashkumar@thenalanda.com, ajit@thenalanda.com

Abstract

Energy recovery is possible from a variety of sources in the surrounding environment. By processing energy sources to charge low-power electronic devices, the radiofrequency energy harvesting system is utilised to capture electromagnetic energy in the atmosphere. A rectifying antenna, also known as a rectifying antenna, converts airborne electromagnetic waves into direct electric current. In this study, we initially designed a patch antenna that is printed on FR4 substrate and has a tiny dimension (40 mm 47.5 mm 1.6 mm).and then the rectifier circuit. This rectenna is capable of working at a frequency range of 2.45 GHz. The antenna was designed using High Frequency Structure Simulator (HFSS) 13.0 software with the result of working frequency of 2.453 GHz, S11 (Return Loss) -52 dB, Voltage Standing Wave Ratio (VSWR) 1.036, gain 3.48 dB and bandwidth 150 MHz. The efficiency of rectifier design on Advanced Design System (ADS) 2011 software is 54% at the input power of 0 dBm at 2.45 GHz. The resulting system is capable of producing electrical energy to power low-power electronic equipment at a DC voltage of 732 mV.

Keywords

Efficiency, Energy Harvesting, Radiofrequency, Rectenna

1. Introduction

The low-energy electronic devices or connected objects manufacturing industry have experienced growth in production in recent years. This growth has led to the implementation and further development of ambient energy recovery systems [1] [2] [3] [4] [5], including radiofrequency (RF) energy harvesting systems. The development of RF energy harvesting systems has been made possible

by the permanent presence of electromagnetic waves or radio waves in the ambient environment. These waves are produced by television and radio stations, Wi-Fi access points, access networks of fixed and mobile telephone operators. One source of energy that is easily obtained is an access point (Wi-Fi). RF systems consist mainly of a rectenna which is an assembly of receiving antenna and rectifier. The receiving antenna picks up the radio signal from the source and converts it into an electrical signal. This electrical signal is then routed through a rectifier which converts it into Direct Current (DC). Microstrip antennas or patch antennas not only considerably allow to reducing the size of the antenna structure, but they are also mechanically robust. Several techniques are developed to design microstrip antennas such as the creation of slots on the radiating element of the antenna. The slots with fractal geometry allowed to increase the bandwidth and the antenna adaptation characteristics [6] [7] [8]. The design of the multiband antenna resulted in a reflection coefficient of -49 dB with a bandwidth of 67 MHz around the resonant frequency of 2400 MHz [8]. A multiband antenna whose radiated element is loaded with circular, L-shaped, and U-shaped slots is designed [9]. The sensor requires a DC voltage to operate. Therefore, in order to power it from the RF system, it is necessary to convert the electrical signal obtained at the output of the antenna to DC power. Moreover, for maximum power transfer, it is important to associate a matching circuit to this rectifier. Thus, an RF to DC conversion efficiency of 84% was obtained with an L-shaped adapter circuit [10]. For a low input power of 0 dBm a rectifier associated with a stub adaptation network allowed to obtain an efficiency of 62% [6]. The analysis of these works shows that microstrip antennas have a low profile with a low bandwidth around their resonant frequency. To increase this bandwidth, the creation of slots on the radiating element of these antennas is important. Rectifier circuits using fewer diodes help to increase the RF-DC conversion efficiency. In this paper, we proposed a compact rectenna operating at 2.45 GHz band for RF energy harvesting. First, three diamond geometry slots are introduced in the patch antenna design to miniaturize it and make it more efficient. Then, two rectangular slots and one circular slot are added to the radiating element to increase the performance of this antenna. A serial rectifier circuit is used to perform the conversion from RF to DC. In addition, a new L-matching stub network is designed to improve the overall efficiency of the rectenna for low input power.

2. Design and Simulation of the Single Band Antenna

The antenna consists of a rectangular geometry with slots loaded on the radiating element. We used a rectangular patch antenna fed by a microstrip line. Rectangular patch antennas have dimensions that can be calculated from equations whose parameters are related to the characteristics of the substrate, the speed of light in vacuum and the frequency of the antenna [11]. The dimensions of the patch are 32 mm \times 42 mm, placed on a Flame Retardant 4 (FR-4) substrate with

relative permittivity = 4.4, thickness = 1.6 mm and loss tangent = 0.02. The ground and the radiating element are each 0.035 mm thick. The microstrip feed-line of the antenna has an impedance of 50Ω . The patch antenna designed by creating diamond-shaped slots on the radiating element is shown in **Figure 1**. To obtain the frequency band with better performance, we considered the patch antenna shown in **Figure 2**. The final structure in **Figure 2** is obtained by creating new rectangular and circular slots on the patch. The dimensions of this antenna are presented in **Table 1**. The evaluation of the reflection coefficient as a function of frequency is shown in **Figure 3**. We can note from **Figure 3** the significant improvement of the reflection coefficient with the final antenna structure. We also note an increase in bandwidth. From the initial structure without slots to the secondary structure, we note an increase of 106.33% in bandwidth and 132.29% with the final structure. The bandwidth is therefore 140 MHz around the resonant frequency of 2.45 GHz.

The increase of antenna performance can therefore be explained by the creation of slots on the radiating element.

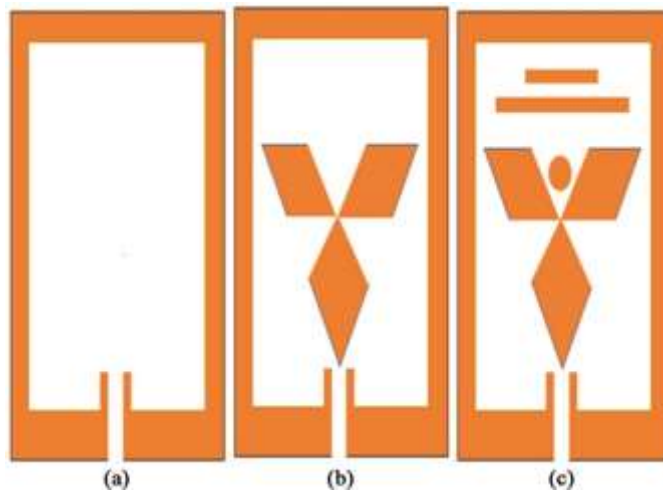

Figure 1. Initial (a) second (b) and final (c) structure of the antenna.

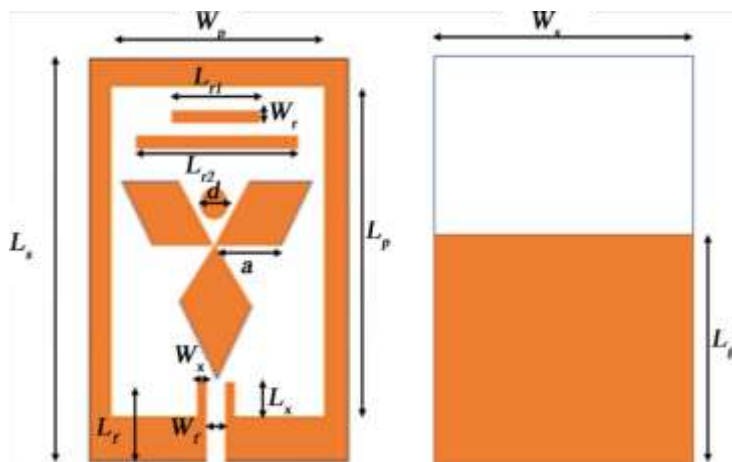

Figure 2. Proposed antenna.

Table 1. Dimensions of the proposed antenna.

Parameters	Values (mm)	Parameters	Values (mm)
W_s	40	L_g	30.5
L_s	47.5	L_x	5
W_p	32	W_x	1.75
L_p	42	L_{r1}	15
W_f	3	L_{r2}	25
L_f	7	W_r	3
a	10	d	4

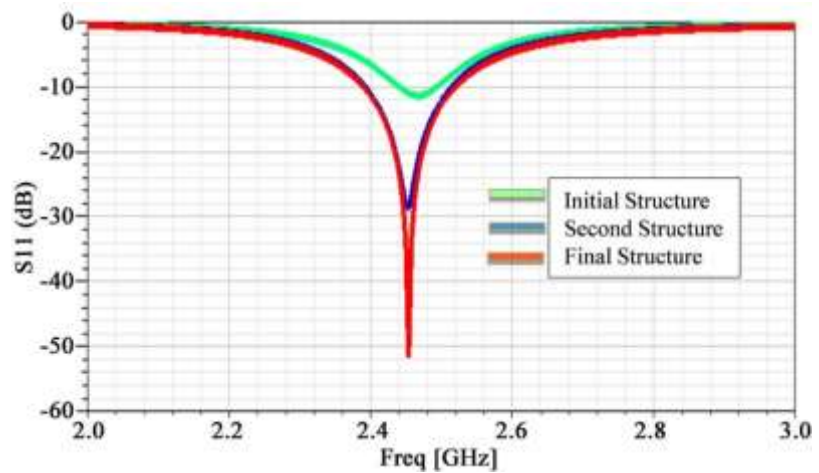

Figure 3. Reflection coefficient variation from initial to final structure.

Table 2. Results of the reflection coefficient (S11) and gain as a function of frequencies.

Structure	Frequency (GHz)	S11 (dB)	Gain (dB)	Bandwidth (MHz)
Initial	2.46	-11.39	2.747	60.100
Second	2.43	-28.78	3.35	124
Final	2.45	-52	3.48	140

Small current flows would have appeared on the radiating element by the presence of slots [6]. This would have led to an increase in the bandwidth and an improvement in the reflection coefficient. **Table 2** shows a comparative study of the three antenna structures. From this table, we also note an improvement of the antenna gain with the final antenna structure. We can deduce from **Table 2** that the creation of slots also increases the antenna gain. The realized gain variation of the final antenna structure is shown in **Figure 4**. At the resonance frequency of 2.45 GHz, we obtain a realized gain of 3.48 dB.

The simulated radiation pattern of the antenna at 2.45 GHz frequencies is plotted in **Figure 5**. The 2 D radiation pattern shows that antenna has an omnidirectional characteristic in the H-plane.

The comparison of our work with others illustrated in **Table 3** shows that the

Figure 4. The antenna gain at 2.45 GHz.

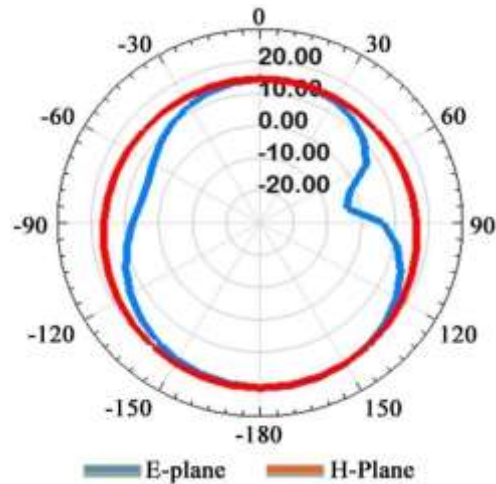

Figure 5. Radiation patterns of the antenna at 2.45 GHz.

Table 3. Comparison between our design and others works.

Ref	Frequency (GHz)	S11 (dB)	Substrate	Antenna shape	Dimensions (mm × mm)	Antenna gain (dB)
[6]	2.45	-50.19	FR4 $\epsilon_r = 4.4$ $\text{tang}\alpha = 0.02$ h = 1.6 mm	Patch fractal slot	NA	2.408
[7]	2.45	-50	FR4 $\epsilon_r = 4.4$ $\text{tang}\alpha = 0.02$ h = 3.2 mm	Patch Fractal slot	38 × 38	2.2
[12]	2.45	-20	FR4 h = 2.5 mm	Patch	35 × 35	0.5
[13]	2.45	-13	FR4 h = 0.8	Patch	41 × 35.5	2.9
This work	2.45	-52	FR4 $\epsilon_r = 4.4$ $\text{tang}\alpha = 0.02$ h = 1.6 mm	Patch Rectangular	40 × 47.5	3.48

designed and simulated antenna has good performances with a better reflection coefficient at a frequency of 2.45 GHz. The comparative study shows also that the designed antenna has the best reflection coefficient. This indicates that the

antenna is highly resonant. This results in a very low signal loss between the antenna and the feed line.

3. Rectifying Circuit Design

The rectifier circuit converts the incoming RF signal received by the antenna into a usable DC voltage for low power applications such as sensors. The topology of the serial rectifier circuit has been chosen.

The selected Schottky diode is the HSMS 2850 type with a series resistance of 25 Ω, a low threshold voltage of 0.25 V and a junction capacitance of 0.18 pF [7]. The matching circuit consists of microstrip lines and inductors. **Figure 6** illustrates the design of the rectifier and adapter circuit under ADS. The complex impedance of the antenna Z_{Source} is 48-j × 0.3 Ohm and that of the load Z_{load} is 1 KΩ. The power levels before and after the rectifier circuits are represented in **Figure 7**. It represents the voltage variations as a function of the frequencies of the source where v_{in} and V_{OUT} are respectively the input and output voltage in the rectifier. We, therefore, note the transfer of direct current power at the output of the rectifier. **Figure 7** shows also that the input voltage to the converter can reach a maximum value of 2 dBm which is obtained at 2.45 GHz. This proves that this device is suitable for low input voltages. The conversion efficiency η at the rectifier terminals can be obtained by the relation (1) [8],

$$\eta = \frac{V_L^2}{P \cdot R_L} 100 \quad (1)$$

where V_L (Volt) is the voltage on the resistor; R_L is the resistance value (1 KΩ) and P is input power (Watt) of receiving antenna. P can be computed according

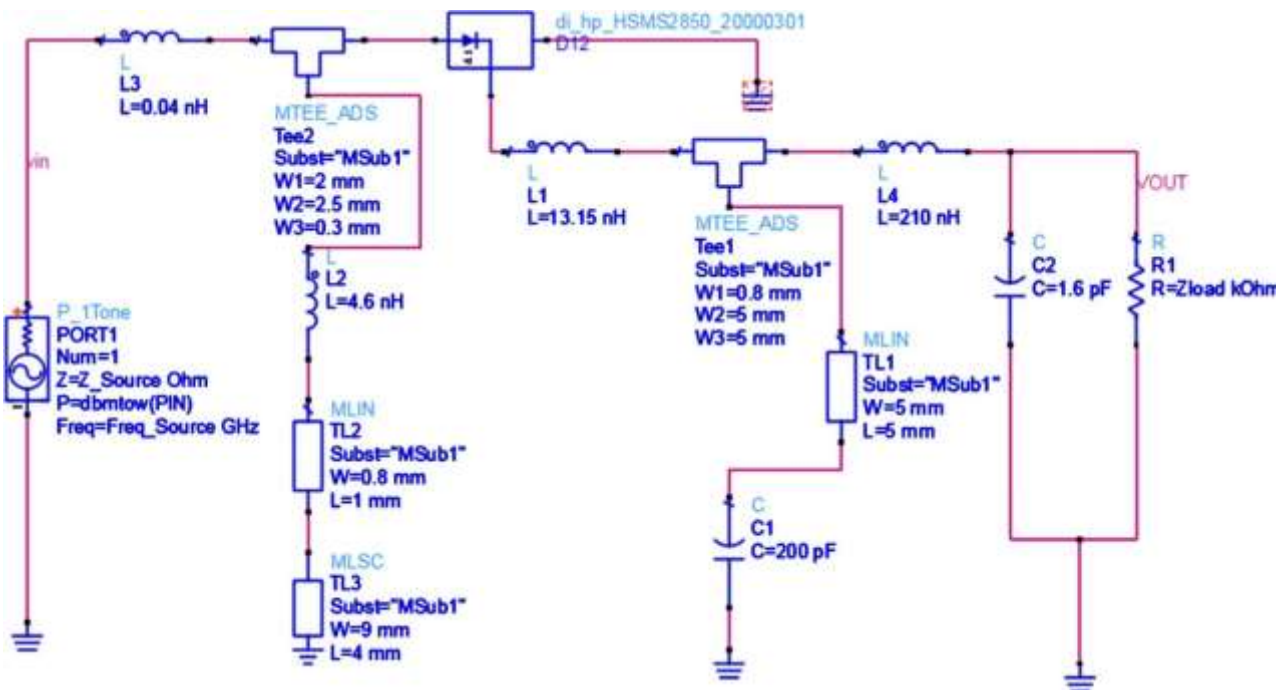

Figure 6. Simulation of the adaptation and rectification circuit.

Figure 7. (a) Input Spectrum power; (b) Output Spectrum power.

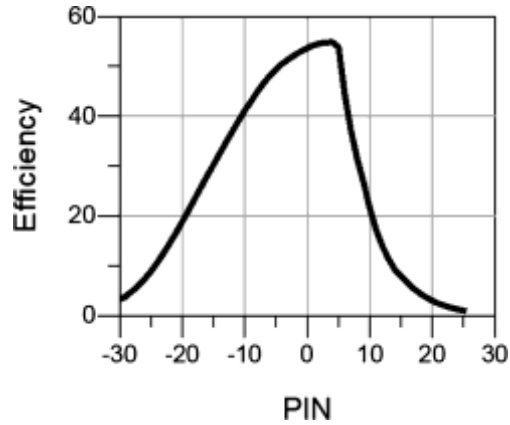

Figure 8. Single band rectifier: RF-to-dc conversion efficiency versus input power (dBm).

to Friis transmission equation [6] as:

$$P_r = \left(\frac{\lambda}{4\pi R} \right)^2 \cdot G_t \cdot G_r \cdot P_t \quad (2)$$

where λ is the wavelength of operating frequency, G_t and G_r are respectively the gain of the transmitting antenna and receiving antenna, P_t is the transmitting power, r is the distance between the two antennas. **Figure 8** shows the RF-DC conversion efficiency. An efficiency of 54% is therefore achieved for an input power of 0 dBm. However, the maximum power transfer efficiency is 55% with an input power of 3 dBm. This curve also indicates that the conversion system is suitable for low input powers. **Figure 9** represents the variation of simulated input and output voltages versus the time for an RF input power of 0 dBm at 2.45 GHz.

The input voltage is sinusoidal while the output voltage is almost constant. We note a higher peak output voltage than the input voltage. The rectifier circuit has therefore not only rectified the input voltage but also amplified it. The designed rectifier gives a maximum output voltage of 732 mV at 2.45 GHz. **Table 4** shows a comparative study of the results of the simulation of rectifier circuit

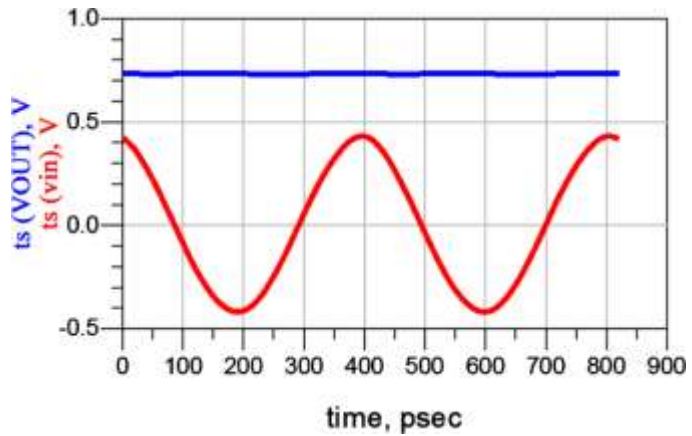

Figure 9. Simulated input and output voltage.

Table 4. Comparison with other rectifier circuits.

Ref	Frequency	Conversion Efficiency at 0 dbm	Load (K Ω)	Topology of rectify
[14]	2.45	55%	2.2	Series diode SMS-7630
[15]	2.45	42%	5	4 Stage of diodes
[16]	2.4	40%	1.8	Voltage quadrupler
This work	2.45	54%	1	Single serie diode HSMS2850

with other works. We obtained a simple rectifier circuit with a good efficiency at 0 dBm and a fairly high output voltage.

4. Conclusion

In this study, we presented a single band antenna operating in the 2.45 GHz frequency region for RF energy harvesting. This antenna is small, performs well at its resonance frequency, and can recover radio waves from Wi-Fi access points. The design of a rectifier circuit utilising a single Schottky diode is covered in the second section. The power conversion efficiency for the antenna using this single diode rectifier is simulated and determined to be 54% at an input power of 0 dBm and a direct rectified voltage of 732 mV. The given receptenna is ideal for Wi-Fi band RF energy harvesting.

References

- [1] Alippi, C. and Galperti, C. (2009) An Adaptive System for Optimal Solar Energy Harvesting in Wireless Sensor Network Nodes. *IEEE Transactions on Circuits and Systems I: Regular Papers*, **55**, 1742-1750. <https://doi.org/10.1109/TCSI.2008.922023>
- [2] Beeby, S.P., Tudor, M.J. and White, N.M. (2006) Energy Harvesting Vibration Sources

- for Microsystems Applications. *Measurement Science and Technology*, **17**, 175-195. <https://doi.org/10.1088/0957-0233/17/12/R01>
- [3] Stark, I. (2006) Thermal Energy Harvesting with Thermo Life. *International Workshop on Wearable and Implantable Body Sensor Networks*, Cambridge, MA, USA, 3-5 April 2006, 19-22. <https://doi.org/10.1109/BSN.2006.37>
- [4] Nechibvute, A., Chawanda, A. and Luhanga, P. (2012) Piezoelectric Energy Harvesting Devices: An Alternative Energy Source for Wireless Sensors. *Smart Materials Research*, **2012**, Article ID: 853481. <https://doi.org/10.1155/2012/853481>
- [5] Agrawal, S., Gupta, R.D., Parihar, M.S. and Kondekar, P.N. (2017) A Wideband High Gain Dielectric Resonator Antenna for RF Energy Harvesting Application. *AEU—International Journal of Electronics and Communications*, **78**, 24-31. <https://doi.org/10.1016/j.aeue.2017.05.018>
- [6] Shi, Y.Y., Jing, J.W., Fan, Y., Yang, L., Li, Y. and Wang, M. (2018) A Novel Compact Broadband Rectenna for Ambient RF Energy Harvesting. *AEU—International Journal of Electronics and Communications*, **95**, 264-270. <https://doi.org/10.1016/j.aeue.2018.08.035>
- [7] Shi, Y.Y., Jing, J.W., Fan, Y., Yang, L., Li, Y. and Wang, M. (2018) Design of a Novel Compact and Efficient Rectenna for WiFi Energy Harvesting. *Progress in Electromagnetics Research C*, **83**, 57-70. <https://doi.org/10.2528/PIERC18012803>
- [8] Assogba, O., Mbodji, A.K., Diallo, A.K. and Diagne, S. (2020) A Novel Compact Multiband Antenna on Fractal Geometry for Ambient RF Energy Harvesting in the LTE/GSM, UMTS and WIFI Bands. 2020 *IEEE International Conf on Natural and Engineering Sciences for Sahel's Sustainable Development—Impact of Big Data Application on Society and Environment (IBASE-BF)*, Ouagadougou, Burkina Faso, 4-6 February 2020, 1-6. <https://doi.org/10.1109/IBASE-BF48578.2020.9069591>
- [9] Singh, N., Kanaujia, B.K., Tariq Beg, M., Mainuddin, S. and Khan, K.T. (2018) A Dual Polarized Multiband Rectenna for RF Energy Harvesting. *International Journal of Electronics and Communications*, **93**, 123-131. <https://doi.org/10.1016/j.aeue.2018.06.020>
- [10] Yang, L., Zhou, Y.J., Zhang, C., Yang, X.M., Yang, X.-X. and Tang, C. (2018) Compact Multiband Wireless Energy Harvesting Based Battery-Free Body Area Networks Sensor for Mobile Healthcare. *IEEE Journal of Electromagnetics, RF and Microwaves in Medicine and Biology*, **2**, 109-115. <https://doi.org/10.1109/JERM.2018.2817364>
- [11] Kuhn, V., Lahuec, C., Seguin, F., *et al.* (2015) A Multi-Band Stacked RF Energy Harvester with RF to DC Efficiency up to 84%. *IEEE Transactions on Microwave Theory and Techniques*, **63**, 1768-1778. <https://doi.org/10.1109/TMTT.2015.2416233>
- [12] Chuma, E.L., de la Torre Rodríguez, L., Iano, Y., Roger, L.L.B. and Sanchez-Soriano, M.A. (2018) Compact Rectenna Based on a Fractal Geometry with a High Conversion Energy Efficiency Per Area. *IET Microwaves, Antennas & Propagation*, **12**, 173-178. <https://doi.org/10.1049/iet-map.2016.1150>
- [13] Mansour, M.M. and Kanaya, H. (2019) Novel L-Slot Matching Circuit Integrated with Circularly Polarized Rectenna for Wireless Energy Harvesting. *Electronics*, **8**, Article No. 651. <https://doi.org/10.3390/electronics8060651>
- [14] Kyriaki, N., Apostolos, G., Ana, C. and Vardakas, J.S. (2014) Dualband Resistance Compression Networks for Improved Rectifier Performance. *IEEE Transactions on Microwave Theory and Techniques*, **62**, 3512-3521. <https://doi.org/10.1109/TMTT.2014.2364830>

- [15] Harsha Vardhan, B.S., Prasad, R.J.C. and Natarajamani, S. (2019) Design of Rectifier at ISM Band for RF Energy Harvesting of Low Powers. *International Conference on Communication and Signal Processing*, 4-6 April 2019, Chennai, India.
<https://doi.org/10.1109/ICCSP.2019.8697979>
- [16] DeLong, B.J., Kiourti, A. and Volakis, J.L. (2018) A Radiating Near-Field Patch Rectenna for Wireless Power Transfer to Medical Implants at 2.4 GHz. *IEEE Journal of Electromagnetics, RF and Microwaves in Medicine and Biology*, **2**, 64-69.
<https://doi.org/10.1109/JERM.2018.2815905>