

# APPLICATION OF COMPACT DUAL BAND PATCH ANTENNA WITH ENHANCED BANDWIDTH

Prasanta Kumar Sahoo<sup>1</sup>, Kaushik Mohanty<sup>2</sup> and Sairukmini Sahu<sup>3</sup>

<sup>1</sup>Aryan Institute of Engineering & Technology, Bhubaneswar, Odisha

<sup>2</sup>NM Institute of Engineering and Technology, Bhubaneswar, Odisha

<sup>3</sup>Capital Engineering College, Bhubaneswar, Odisha

## Abstract

A Dual band reduced and streamlined fix radio wire with a rearranged L space on the ground plane is introduced for X and C band applications. A 10 mm×10 mm ×1.6 mm fix is planned and manufactured on FR4 substrate with co-pivotal test took care of excitation. The fix resonates in X and C groups because of the state of the fix as  $\Psi$  and by setting a reversed L opening on a ground plane. The radio wire is resonating at 5.21 GHz & 10.85 GHz giving a return loss of -23.28dB and -24.83dB. In X-band (8GHz-12GHz) the radio wire is giving an impedance transmission capacity of 2.81 GHz from 10GHz – 12.81GHz with  $S_{11} < -10$ dB and in C Band it is giving an impedance transfer speed of 590MHz from 4.92GHz – 5.51GHz. A greatest directivity of 5.99dBi and 7.13dBi is acquired in the reverberating groups. With a solitary feed the proposed radio wires that are a conservative and electrically little size (ESA), display an exceptionally steady radiation design which meets the pragmatic prerequisites for remote applications. In ESA radiation is because of both fix and ground plane. An examination concentrate on shows that the proposed radio wire has further developed data transmission in the ideal groups with diminished size. The outcomes show that the receiving wire can be utilized for Synthetic Aperture Radar (SAR) applications.

**Keywords:** C-band, ESA, FR4 substrate material, MOM, SAR, X-band.

## INTRODUCTION

The Micro-strip patch antennas has achieved focus due to its major attractive features such as less profile, low weight, low cost, easy to fabricate, conformal to the surface and can be easily embedded into PCB. It consists of a dielectric substrate by placing a patch on one side and ground plane on the other side. Apart from advantages, it has limitations as lower bandwidth and low efficiency [1].

To overcome these limitations, many techniques have been proposed in the literature. Different techniques for size reduction have been proposed such as placing shorting posts and walls [2], loading inductors or capacitors or using meta-material structure. To realize multiband functions i.e. to get fundamental and higher order modes, different techniques are

employed, using defected ground plane structure [3] or, split ring resonator [4]. To enhance the bandwidth different techniques are proposed, placing U, E, L and T slots on patch and by modifying the ground plane [5-7] but these are large in size and give less gain. A modified  $\Psi$  shaped patch antenna is proposed with reduced size by placing a shorting post but on infinite ground plane [8-11] and all these includes L,S,C bands. Among these modifying the shape of the patch and ground plane (by placing slots) are the easier methods with respect to design and size.

Due to high data transmission rates, short range and large bandwidth X band technology has been broadly used. A circular and rectangular slot antenna for X-band applications is proposed but this gives a bandwidth of 1.5 GHz and of 40x40mm in size [12]. A quad band patch antenna with u slot on patch is proposed with 67 x 74 mm size for C,X and Ku band applications gives less bandwidth and large in size [13]. A dual band patch using shorting post and DGS technique is proposed on RO4350 with a size of 20 x 18.8mm [14]. An Inverted S-shaped patch antenna is proposed for X band applications but with less bandwidth and 3 times resonating in X band with a size of 20 x 17.2mm [15].

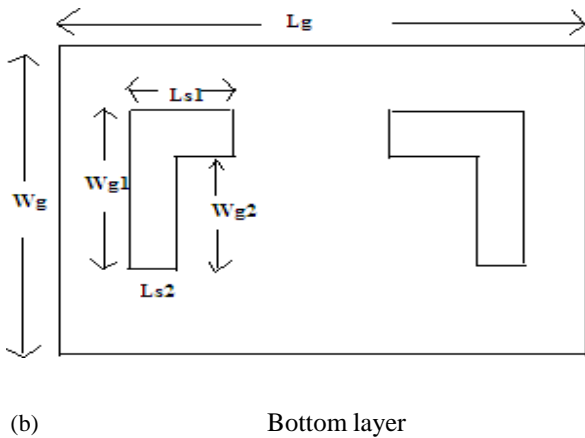
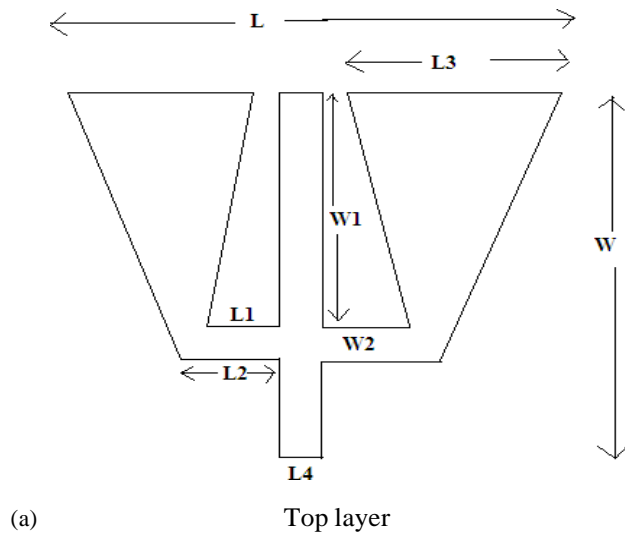
In this paper, we proposed a compact simple dual band antenna which covers SAR applications. The patch resonates in C band and X band due to the shape as modified  $\psi$  and also by placing an inverted L slot on ground plane. Parametric study with respect to slot length and width shows the variation in resonance. Antenna geometry and design is discussed in detail in II part, Results and discussions in III part.

## Antenna Geometry and Design

To enhance the bandwidth in the desired band, used a modified  $\Psi$  shaped patch and on ground plane etched an inverted L slot. The designed patch antenna uses FR4 substrate with a height of 1.59 mm that has relative permittivity of 4.5 and dielectric loss tangent of 0.025. The designed antenna is fed with coaxial probe. The SMA connector with 50 $\Omega$  impedance is connected at (5, 3.325) as a feeding line with a radius of 0.36mm.

Table 1: Proposed Antenna Specifications

Parameter	W	L	W1	W2	L1	L2	L3
Size in mm	10	10	6.375	0.625	1.2	2.9	4.6
Parameter	Wg	Lg	Ls1	Ls2	Wg1	Wg2	L4
Size in mm	10	10	3	1	3	2	0.4



## RESULTS AND DISCUSSION

In order to simulate the patch we use Integrated Electromagnetic 3 dimension (IE3D). Return loss indicates the amount of power reflected back, for MPA's the acceptable value of  $S_{11}$  must be less than  $-10\text{dB}$ . Here we started with the design of patch antenna first by placing antenna on infinite ground plane which is resonating at  $11.25\text{GHz}$  and is giving  $S_{11} < -10\text{dB}$  from  $10.04\text{GHz} - 12.81\text{GHz}$  giving an impedance bandwidth of  $2.77\text{GHz}$ . Then same structure is placed finite ground plane of  $10\text{mm} \times 10\text{mm}$  without slots which is resonating at  $9.72\text{GHz}$  and is giving  $S_{11} < -10\text{dB}$  from  $9.43\text{GHz} - 11.51\text{GHz}$  excluding from  $10\text{GHz} - 10.5\text{GHz}$ , giving an impedance bandwidth of  $2.07\text{GHz}$ . Finally by making an inverted L shaped slots on ground plane keeping the structure same the patch is resonating at two frequencies  $5.19\text{GHz}$  and  $10.85\text{GHz}$  and is giving  $S_{11} < -10\text{dB}$  from  $4.9\text{GHz} - 5.4\text{GHz}$  giving an impedance bandwidth of  $500\text{MHz}$  in the first band and is giving  $S_{11} < -10\text{dB}$  from  $9.75\text{GHz} - 11\text{GHz}$  giving an impedance bandwidth of  $1.25\text{GHz}$  in the second band. The dual band is obtained by making an inverted L slots on the ground plane. It can be observed that the antenna is giving a highly isolated frequency bands with a maximum frequency ratio  $f_2/f_1$  is equal to  $2.09$ . Figure 2 shows the simulation return loss of all these patch antennas. Table 2 shows the parameter comparison of all these patch antennas

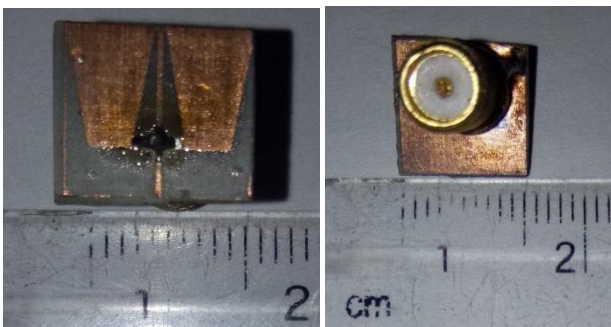


Figure 1: Geometries of the proposed and fabricated Patch antenna.

The Geometry of the patch antenna and ground plane, the fabricated patch antenna (top and bottom layers) is shown in fig 1. Bandwidth and size are considered as objectives to design the patch antenna by using the design procedure the proposed antenna specifications are tabulated in table 1.

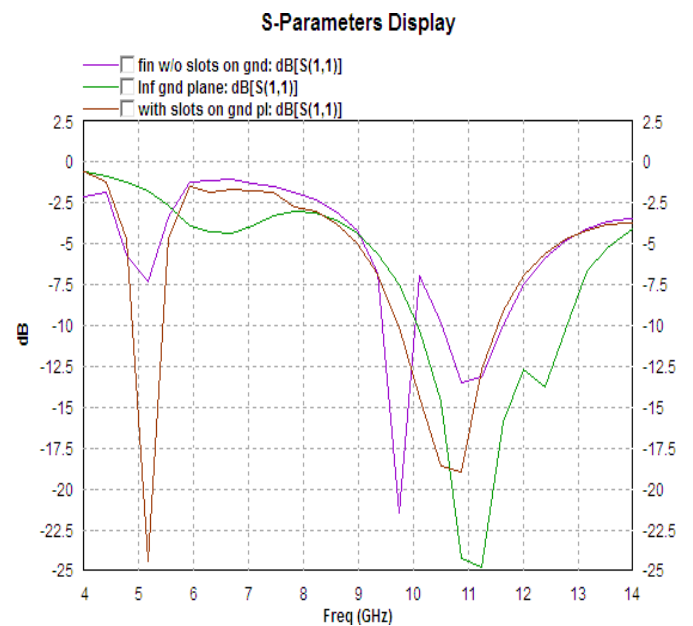
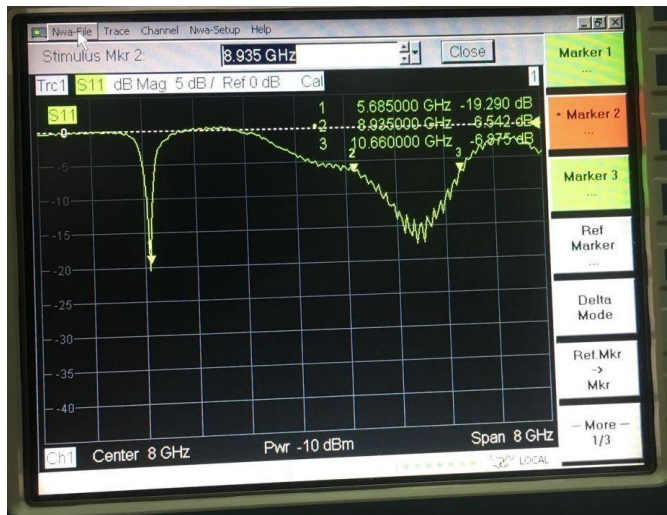


Figure 2: Return Loss of the antenna

Fig 3 shows the measured return loss from vector network analyzer (VNA). It is shown that in C band it is resonating at 5.685GHz and in X band at 9.89GHz. As it is an ESA -6dB bandwidth is considered, at lower band it is giving a 300MHz and at upper band 1.735GHz. A slight variation in resonance is due to fabrication errors as it is an ESA and also the connector model is not chosen in simulation constitutes to the variation in matching levels.



**Figure 3:** Measured Return loss from VNA

**Table 2:** Comparison results of the patch antennas

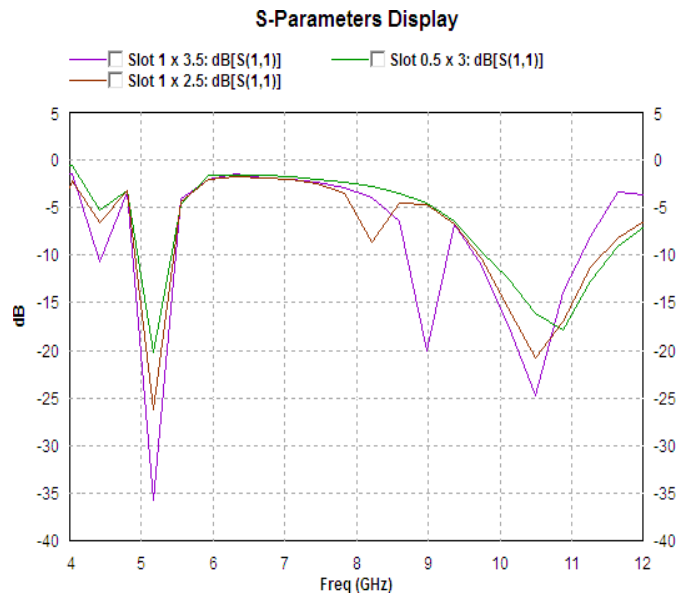
Antennas	Return Loss (S <sub>11</sub> < -10dB)	Bandwidth in GHz	Resonating Frequency f <sub>0</sub> in GHz
Patch on Infinite ground plane	10.08GHz – 12.78GHz	2.77GHz	11.25GHz
Patch on finite ground plane without slots	9.43GHz – 11.51GHz	2.07GHz	9.72GHz
Patch on finite ground plane with slots	4.9GHz – 5.4GHz & 9.75GHz – 11GHz	500MHz & 1.25GHz	5.19GHz & 10.25GHz

**Parametric Evaluation**

**Variation of slot length and width on ground plane:**

To investigate the effect of length and width of the slot on ground plane, one is varied at a time and observed the antenna resonance and the bandwidth at two bands which is tabulated in table 3. By changing width to 3.5mm we get tri band i.e. on C band and X band. This shows that width changes the higher

resonance and S<sub>11</sub> decreases at lower resonance. By increasing width of the slot bandwidth increases in 1st and 2nd band. By decreasing the length of the slot bandwidth decreases in 1st band and increases in 2nd band. By increasing the width of the slot difference between 1st and 2nd band decreases and by decreasing the length of the slot difference between resonating bands increases. Figure 4 shows the effect of slot length and width variations on resonance and bandwidth.



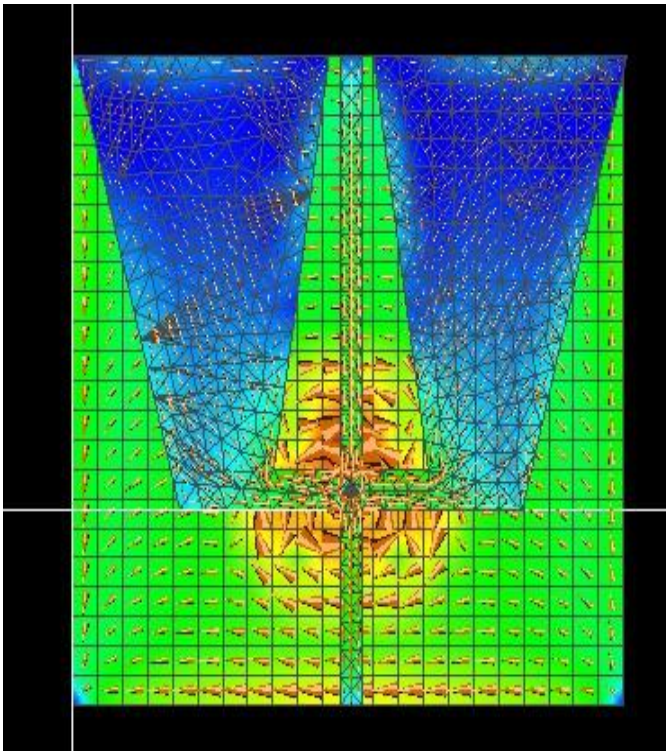
**Figure 4:** Return Loss of the antenna

**Table 3:** Comparison results of the patch antennas

Length and Width of the Slot on Ground Plane in mm	1 <sup>st</sup> Band resonance (S <sub>11</sub> < -10dB)	2 <sup>nd</sup> Band Resonance (S <sub>11</sub> < -10dB)	Bandwidth	Difference between 1 <sup>st</sup> & 2 <sup>nd</sup> Band
1 X 3.5	4.88GHz – 5.49GHz	8.71GHz – 9.26GHz & 9.63GHz – 11.13GHz	610MHz, 550MHz & 1.5GHz	3.83GHz
1 X 2.5	4.91GHz – 5.45GHz	9.71GHz – 11.4GHz	540MHz & 1.69GHz	4.8GHz
0.5 X 3	4.95GHz – 5.42GHz	9.78GHz – 11.53GHz	470MHz & 1.75GHz	4.83GHz

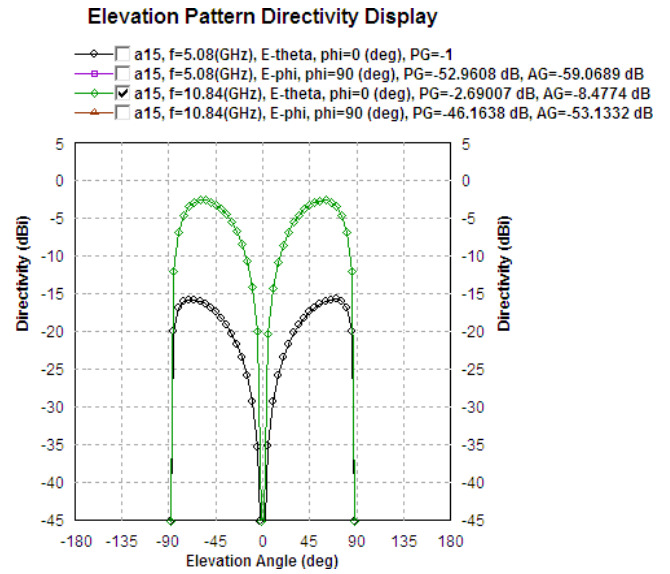
From current distribution we can observe that higher order modes as TM<sub>21</sub> are introduced due to the slots made on patch and on ground plane which makes the patch to resonate at nearby frequencies thus increases the bandwidth which is shown in figure 5. Due to the slot on ground plane makes the patch to resonate at 5.2 GHz along with X band.

The directivity of the patch antenna at the resonating frequencies is 5.99dBi and 7.13dBi respectively. As the proposed antennas are electrically small antenna (ESA), there will be a radiation from both ground plane and patch. The radiation pattern (3D) show that the radiation is broadside and also indicates directivity of 7.13dBi and 5.99dBi at the resonating frequencies. The radiation pattern is symmetrical about y axis.

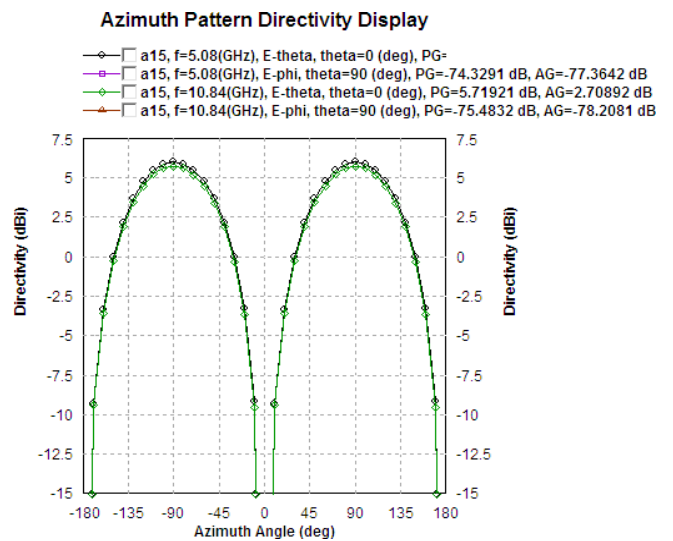


**Figure 6:**Current Distribution at  $f_0$

Figure 7 shows the co-polar and cross polar components at the resonating frequencies 5.08 GHz and 10.84GHz. From figure we can observe that cross polar components are less than -20db in both E (elevation ) and H(azimuthal)plane .



(a) E plane



(b) H plane

**Figure 8:** Co and cross polarization components along H and E plane at the resonating frequencies.

**Table 4:** Comparison Study with respect to literature

Parameters	[5]	[12]	[13]	[14]	[15]	Our Work
Resonating Frequency in GHz	5.26 & 5.75	10.25 & 11.54	5.35, 8.25, 9.85 & 13.95	2.4 & 5.2	9.08, 11.02 11.78	10.53 & 11.76
Bandwidth in GHz	0.62	1.59	300, 1.05, 0.25 & 0.95	0.04 & 0.5	0.45, 1.01 & 0.45	0.59 & 2.81
Radiating Patch Size including ground plane in mm	67 X 74 X 3.17	40 x 40 x 1.6	67 X 74 X 3.17	20 X 18.8 X 0.76	20 X 17.2 X 1.6	10 X 10 X 1.6
Return Loss at resonating frequencies in dBi	-23 & -16	-17.14 & -14.29	-33.27, -23.35, -25.06 & -22.65	-30 & -17	-24.8	-24.86 & -23.56

## CONCLUSION

A dual band highly miniaturized patch antenna for C and X-band applications is presented here. The antenna is resonating at 5.21 GHz & 11.24 GHz giving an impedance bandwidth of 2.81 GHz from 10 GHz – 12.81 GHz in X band and in C band giving an impedance bandwidth of 590 MHz from 4.92 GHz – 5.51 GHz. The proposed patch antenna is fabricated on FR4 board with 10 x 10 x 1.6mm and the measured results had a good agreement with the simulated one. The patch is giving a maximum directivity of 7.13dBi. The proposed compact (ESA) is resonating in C and X bands due to the shape of patch as  $\Psi$  and has an inverted L slot on ground plane. Parametric study with respect to slot length and width on ground plane reveals a variation in resonance and the results are tabulated. Comparison study reveals that the proposed antennas have attractive results of low cross polarization, good radiation patterns with high directivity, improved bandwidth and compact in size proves that the proposed antenna can be used for X and C band applications.

## REFERENCES

- [1] Kumar G. and Ray K.P., *Broadband Microstrip Antennas*, Artech House, Boston, 2003.
- [2] M. Yang, Z. N. Chen, P. Y. Lau, X. Qing, and X. Yin, "Miniaturized patch antenna with grounded strips," *IEEE Trans. Antennas Propag.*, vol. 63, no. 2, pp. 843–848, Feb. 2015.
- [3] J. J. Wei, A.-G. Wang, S. Gao, and W. Leng, "Miniaturized triple-band antenna with a defected ground plane for WLAN/WiMAX applications," *IEEE Antennas Wireless Propag. Lett.*, vol. 10, pp. 298–301, 2011.
- [4] D. Sarkar, K. Saurav, and K. V. Srivastava, "Multi-band microstrip-fed slot antenna loaded with split-ring resonator," *Electron. Lett.*, vol. 50, no. 21, pp. 1498–1500, Oct. 2014.
- [5] Ahmed Khidre, Kai-Fong Lee, Atef Z. Elsherbeni, Fan Yang, "Wide Band Dual Beam U-Slot Microstrip Antenna", *IEEE Transactions on Antennas and Propagation*, 61 (2013), 1415 - 1418. <http://dx.doi.org/10.1109/tap.2012.2228617>.
- [6] A. Dastranj and H. Abiri, "Bandwidth enhancement of printed E-shaped slot antennas fed by CPW and Microstrip line," *IEEE Trans. Antennas Propag.*, vol. 58, no. 4, pp. 1402-1407, 2010.
- [7] Kaushik Mandal and Partha Pratik Sarkar "High Gain Wide-Band U-Shaped Patch Antennas With Modified Ground Planes" *IEEE Trans. Antennas Propag.*, vol. 61, no. 4, pp. 2279-2282, Apr-2013.
- [8] S. K. Sharma and L. Shafai, "Investigations of a novel  $\psi$ -shape microstrip patch antenna with wide impedance bandwidth," in *Proc. IEEE Int. Symp. Antennas Propag.*, HI, Jun. 10–15, 2007, pp. 881–884.
- [9] Anitha P, A.S R Reddy , M.N Giri Prasad "Performance Analysis of Compact CPW-Fed Modified  $\psi$ -Shaped Micro-strip Antenna for Dual Band" *International Conference on Communication and Signal Processing*, IEEE, April 6-8, 2016, India
- [10] Anitha P, A.S R Reddy , M.N Giri Prasad "Performance comparison of Modified  $\psi$ -Shaped Micro-strip Antenna with compact shorted  $\psi$ -Shaped patch" *Proceedings of ICMARS*, Dec 15-17, 2015, Jodhpur, India
- [11] Anitha P, A.S R Reddy , M.N Giri Prasad "Design of a Compact  $\psi$ -shaped Micro-strip Patch antenna on Modified Ground Planes" *ICRAECT, IEEE*, Mar 23-25, 2017, India
- [12] M. M. Islam, M. T. Islam, M. R. I. Faruque, W. Hueyshin "Design of an X-band microstrip patch antenna with Enhanced bandwidth" *2nd International Conference on Advances in Electrical Engineering (ICAEE 2013) IEEE*, 19-21 December, 2013, Dhaka, Bangladesh
- [13] M. Sugadev , E. Logashanmugam J.-Y. Sze, and K. -L. Wong, "Quad Band U-Slot Microstrip Antenna for C, X and Ku Band Wireless Applications," *Contemporary Engineering Sciences*, Vol. 8, 2015, no. 16, 737-745 HIKARI Ltd.,
- [14] Ahmad A. Salih and Mohammad S. Sharawi "Highly Miniaturized Dual band Patch Antenna" *Antennas and Propagation (EuCAP), 2016 10th European Conference on 10-15 April 2016* 10.1109/EuCAP.2016.7481998
- [15] M. Samsuzzaman and M. T. Islam "Inverted S-Shaped Compact Antenna for X-Band Applications" *Hindawi Publishing Corporation The Scientific World Journal* Volume 2014, Article ID 604375, 11 pages <http://dx.doi.org/10.1155/2014/604375>.